

# T-1<sup>3/4</sup> (5 mm) Diffused LED Lamps

## Technical Data

**HLMP-3300 Series**  
**HLMP-3400 Series**  
**HLMP-3500 Series**  
**HLMP-3762**  
**HLMP-3862**  
**HLMP-3962**  
**HLMP-D400 Series**  
**HLMP-D600**

### Features

- **High Intensity**
- **Choice of 4 Bright Colors**  
High Efficiency Red  
Orange  
Yellow  
High Performance Green
- **Popular T-1<sup>3/4</sup> Diameter Package**
- **Selected Minimum Intensities**
- **Wide Viewing Angle**
- **General Purpose Leads**

- **Reliable and Rugged**
- **Available on Tape and Reel**

### Description

This family of T-1<sup>3/4</sup> tinted, diffused LED lamps is widely used in general purpose indicator applications. Diffusants, tints, and optical design are balanced to yield superior light output and wide viewing angles. Several intensity choices are available in each color for increased design flexibility.

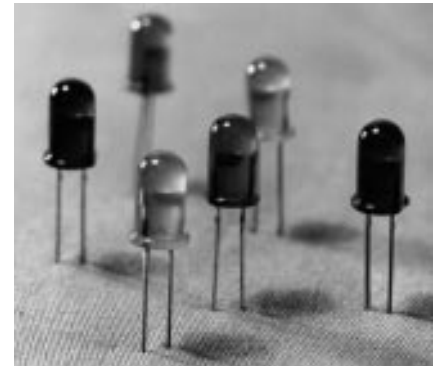

### Selection Guide

Part Number HLMP-	Application	Minimum Intensity (mcd) at 10 mA	Color (Material)
3300	General Purpose	2.1	High Efficiency Red (GaAsP on GaP)
3301	High Ambient	5.4	
3762	Premium Lamp	8.6	
D400	General Purpose	2.1	Orange (GaAsP on GaP)
D401	High Ambient	5.4	
3400	General Purpose	2.2	Yellow (GaAsP on GaP)
3401	High Ambient	5.7	
3862	Premium Lamp	9.2	
3502	General Purpose	1.6	Green (GaP) 565 nm
3507	High Ambient	4.2	
3962	Premium Lamp	10.6	
D600 <sup>[1]</sup>	General Purpose	1.0	Emerald Green (GaP) 558 nm

**Note:**

1. Please refer to Application Note 1061 for information comparing standard green and emerald green light output degradation.

## Package Dimensions

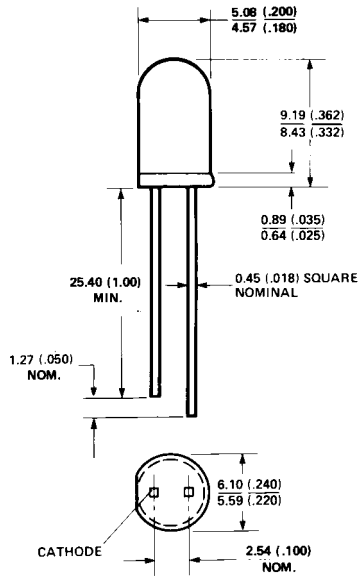

- NOTES:  
 1. ALL DIMENSIONS ARE IN MILLIMETRES (INCHES).  
 2. AN EPOXY MENISCUS MAY EXTEND ABOUT 1mm (.040") DOWN THE LEADS.

## Optical/Electrical Characteristics at $T_A = 25^\circ\text{C}$

Symbol	Parameter	Device HLMP-	Min.	Typ.	Max.	Units	Test Conditions
$I_V$	Luminous Intensity	High Efficiency Red				mcd	$I_F = 10 \text{ mA}$
		3300	2.1	3.5			
		3301	5.4	7.0			
		3762	8.6	12.0			
		Orange					
D400	2.1	3.5					
D401	5.4	7.0					
Yellow	3400	2.2	4.0				
		3401	5.7	8.0			
		3862	9.2	12.0			
Green	3502	1.6	2.4				
		3507	4.2	5.2			
		3962	10.6	14.0			
Emerald Green							
D600	1.0	3.0					
$2\theta^{1/2}$	Included Angle Between Half Luminous Intensity Points	High Efficiency Red Orange Yellow Green Emerald Green		60 60 60 60 60		Deg.	$I_F = 10 \text{ mA}$ See Note 1
$\lambda_{\text{PEAK}}$	Peak Wavelength	High Efficiency Red Orange Yellow Green Emerald Green		635 600 583 565 558		nm	Measurement at Peak

### Optical/Electrical Characteristics at $T_A = 25^\circ\text{C}$ (cont.)

Symbol	Parameter	Device HLMP-	Min.	Typ.	Max.	Units	Test Conditions
$\Delta\lambda_{1/2}$	Spectral Line Halfwidth	HER/Orange Yellow Green Emerald Green		40 36 28 24		nm	
$\lambda_d$	Dominant Wavelength	High Efficiency Red Orange Yellow Green Emerald Green		626 602 585 569 560		nm	See Note 2
$\tau_s$	Speed of Response	High Efficiency Red Orange Yellow Green Emerald Green		90 280 90 500 560		ns	
C	Capacitance	High Efficiency Red Orange Yellow Green Emerald Green		11 4 15 18 3100		pF	$V_F = 0$ ; $f = 1 \text{ MHz}$
$R\theta_{J-PIN}$	Thermal Resistance	All		260		$^\circ\text{C/W}$	Junction to Cathode Lead
$V_F$	Forward Voltage	HER/Orange Yellow Green Emerald Green		1.9 2.0 2.1 2.1	2.4 2.4 2.7 2.7	V	$I_F = 10 \text{ mA}$
$V_R$	Reverse Breakdown Voltage	All	5.0			V	$I_R = 100 \mu\text{A}$
$\eta_V$	Luminous Efficacy	High Efficiency Red Orange Yellow Green Emerald Green	– –	145 380 500 595 656		$\frac{\text{lumens}}{\text{Watt}}$	See Note 3

**Notes:**

- $\theta^{1/2}$  is the off-axis angle at which the luminous intensity is half the axial luminous intensity.
- The dominant wavelength,  $\lambda_d$ , is derived from the CIE chromaticity diagram and represents the single wavelength which defines the color of the device.
- Radiant intensity,  $I_e$ , in Watts/steradian, may be found from the equation  $I_e = I_v/\eta_v$ , where  $I_v$  is the luminous intensity in candelas and  $\eta_v$  is the luminous efficacy in lumens/Watt.

### Absolute Maximum Ratings at $T_A = 25^\circ\text{C}$

Parameter	HER/Orange	Yellow	Green/ Emerald Green	Units
Peak Forward Current	90	60	90	mA
Average Forward Current <sup>[1]</sup>	25	20	25	mA
DC Current <sup>[2]</sup>	30	20	30	mA
Power Dissipation <sup>[3]</sup>	135	85	135	mW
Reverse Voltage ( $I_R = 100 \mu\text{A}$ )	5	5	5	V
Transient Forward Current <sup>[4]</sup> (10 $\mu\text{sec}$ Pulse)	500	500	500	mA
LED Junction Temperature	110	110	110	$^\circ\text{C}$
Operating Temperature Range	-55 to +100	-55 to +100	-20 to +100	$^\circ\text{C}$
Storage Temperature Range			-55 to +100	
Lead Soldering Temperature [1.6 mm (0.063 in.) from body]	260 $^\circ\text{C}$ for 5 seconds			

**Notes:**

1. See Figure 5 (Red/Orange), 10 (Yellow), or 15 (Green) to establish pulsed operating conditions.
2. For Red, Orange and Green series derate linearly from 50 $^\circ\text{C}$  at 0.5 mA/ $^\circ\text{C}$ . For Yellow series derate linearly from 50 $^\circ\text{C}$  at 0.2 mA/ $^\circ\text{C}$ .
3. 1.8 mW/ $^\circ\text{C}$ . For Yellow series derate power linearly from 50 $^\circ\text{C}$  at 1.6 mW/ $^\circ\text{C}$ .
4. The transient peak current is the maximum non-recurring peak current that can be applied to the device without damaging the LED die and wirebond. It is not recommended that the device be operated at peak currents beyond the peak forward current listed in the Absolute Maximum Ratings.

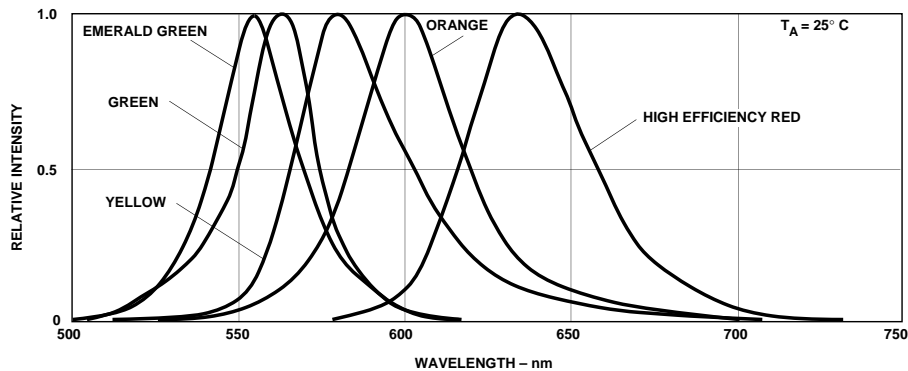

Figure 1. Relative Intensity vs. Wavelength.

# T-1<sup>3/4</sup> High Efficiency Red, Orange Diffused Lamps

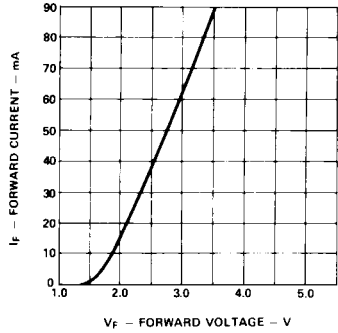

Figure 2. Forward Current vs. Forward Voltage Characteristics.

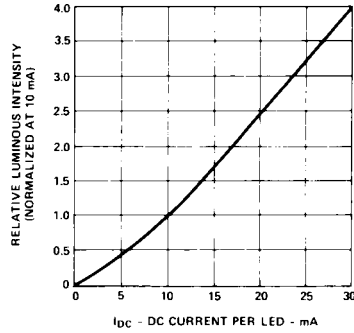

Figure 3. Relative Luminous Intensity vs. DC Forward Current.

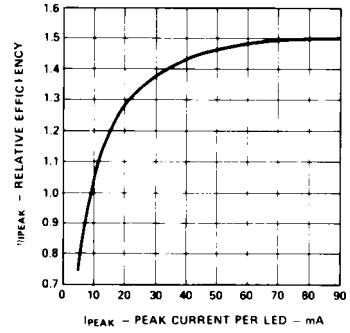

Figure 4. Relative Efficiency (Luminous Intensity per Unit Current) vs. Peak LED Current.

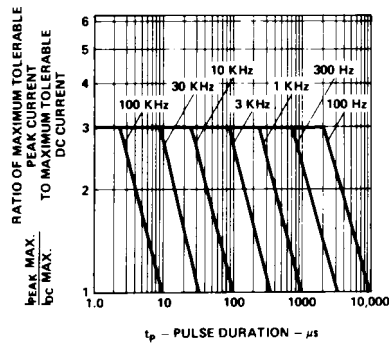

Figure 5. Maximum Tolerable Peak Current vs. Pulse Duration. ( $I_{DC}$  MAX as per MAX Ratings).

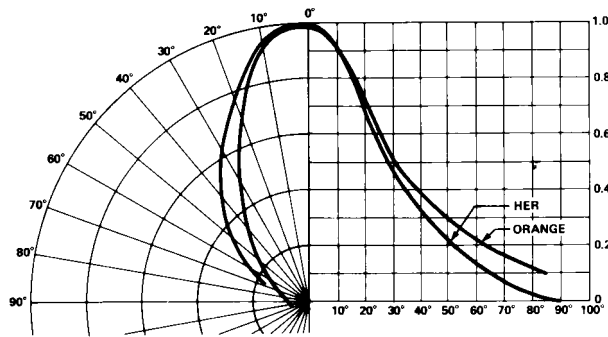

Figure 6. Relative Luminous Intensity vs. Angular Displacement.

# T-1<sup>3</sup>/<sub>4</sub> Yellow Diffused Lamps

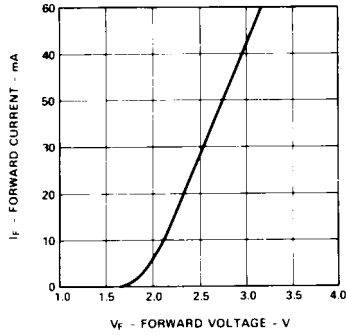

Figure 7. Forward Current vs. Forward Voltage Characteristics.

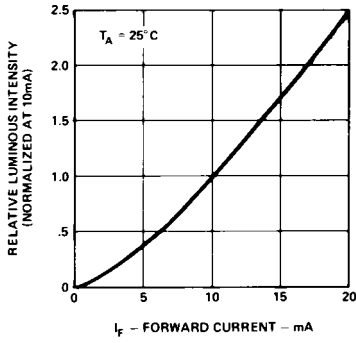

Figure 8. Relative Luminous Intensity vs. Forward Current.

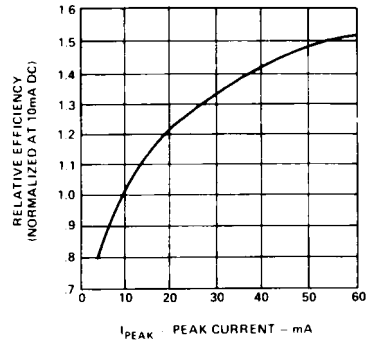

Figure 9. Relative Efficiency (Luminous Intensity per Unit Current) vs. Peak Current.

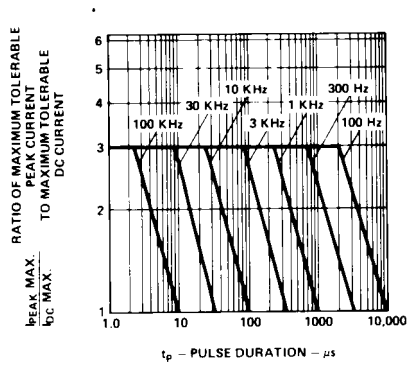

Figure 10. Maximum Tolerable Peak Current vs. Pulse Duration. ( $I_{DC}$  MAX as per MAX Ratings).

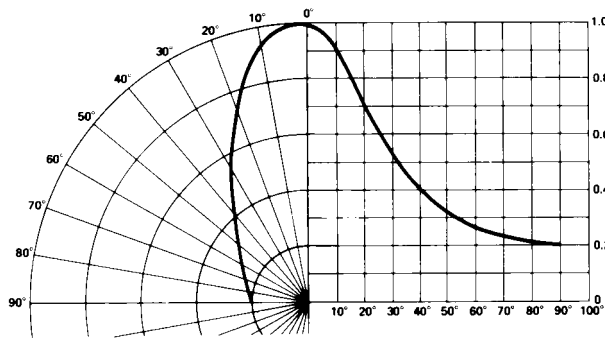

Figure 11. Relative Luminous Intensity vs. Angular Displacement.

# T-1<sup>3</sup>/<sub>4</sub> Green/Emerald Green Diffused Lamps

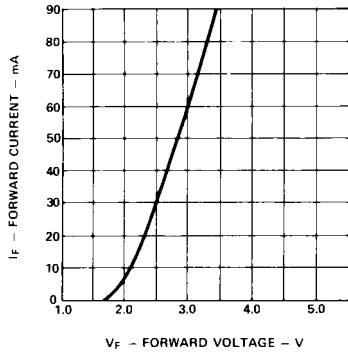

Figure 12. Forward Current vs. Forward Voltage Characteristics.

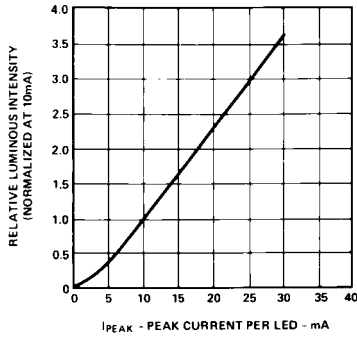

Figure 13. Relative Luminous Intensity vs. DC Forward Current.

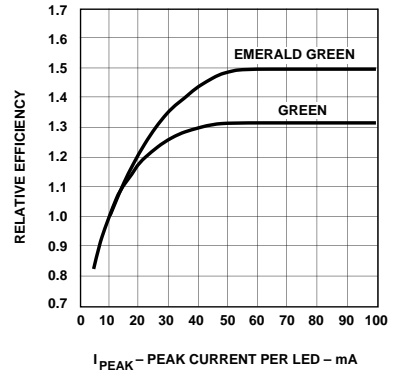

Figure 14. Relative Efficiency (Luminous Intensity per Unit Current) vs. Peak LED Current.

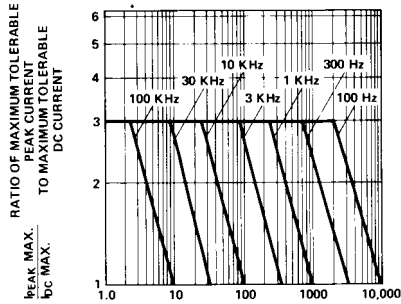

Figure 15. Maximum Tolerable Peak Current vs. Pulse Duration. ( $I_{DC}$  MAX as per MAX Ratings).

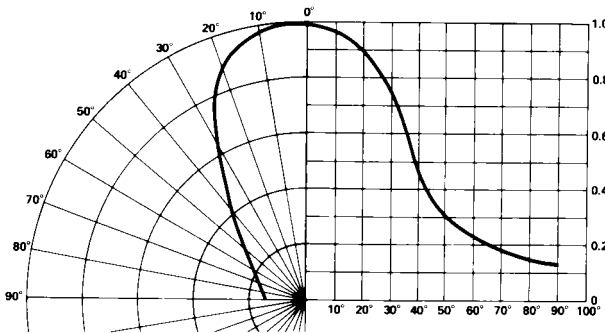

Figure 16. Relative Luminous Intensity vs. Angular Displacement.