

SMC 072

Modular Supports



Width of PCB:
72 mm (2.835 in)



Support Type:
MODULAR



Standard Colour:
GREEN



Thickness of PCB:
.063 in (1.6 mm)



SMC072



SMC 072

Modular Supports for 72 mm (2.835 in) Wide Boards

Base Elements with two Lateral Elements and one or two DIN Rail Hooks are combined together in order to obtain PCB Supports according to the following table.

For 11 mm (.433 in) wide PCBs, a single Complete Module is provided by assembling two parts together.

Modular Supports for 72 mm (2.835 in) Wide Boards

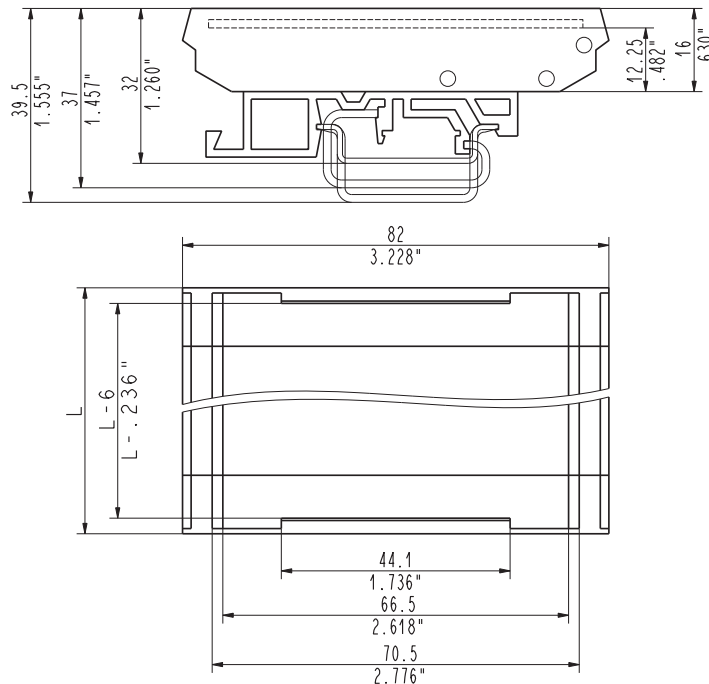

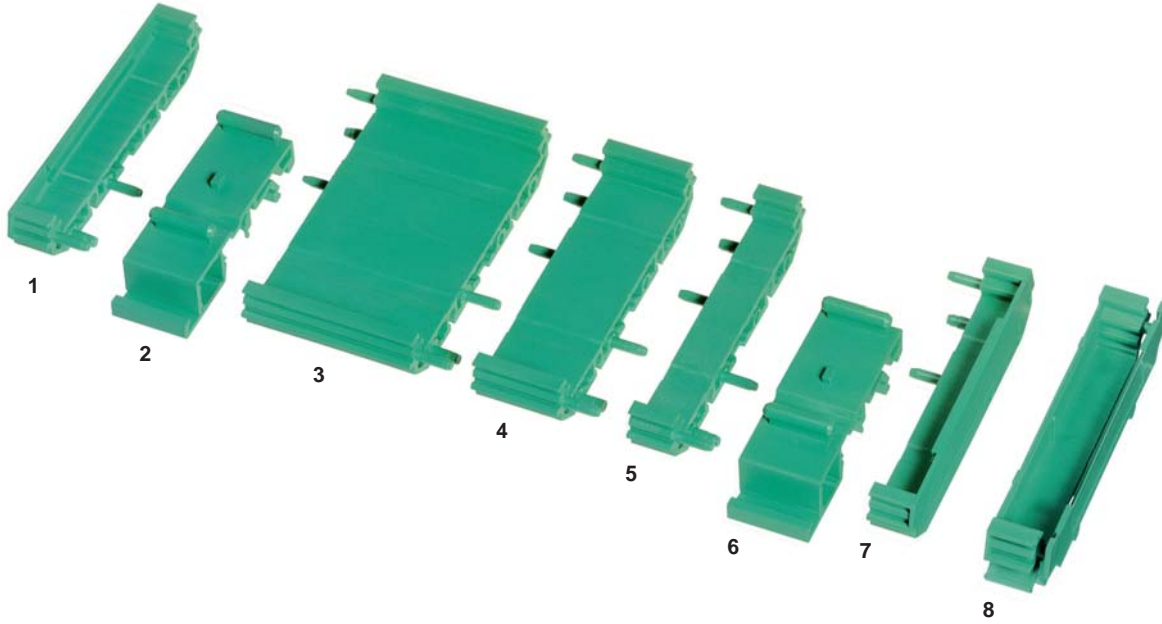

- 1 SMC072T011
- 2 SMC072P020
- 3 SMC072S045
- 4 SMC072S022
- 5 SMC072S011
- 6 SMC072P020
- 7 SMC072T011
- 8 SMC072T013

Lateral Element

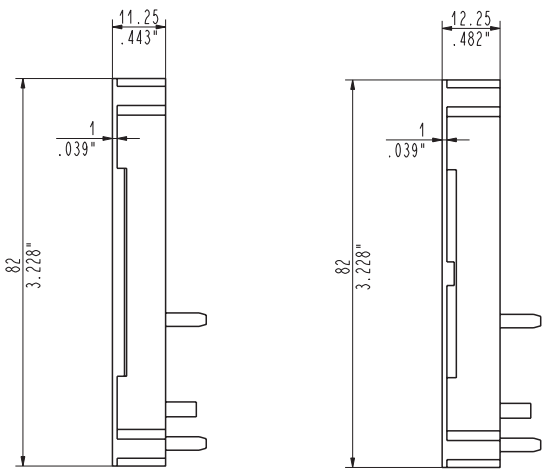

SMC072T011

SMC072T012

Base Element

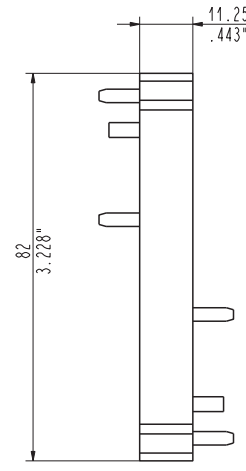

SMC072S011

Base Element

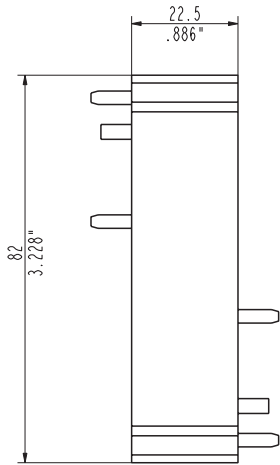

SMC072S022

Base Element

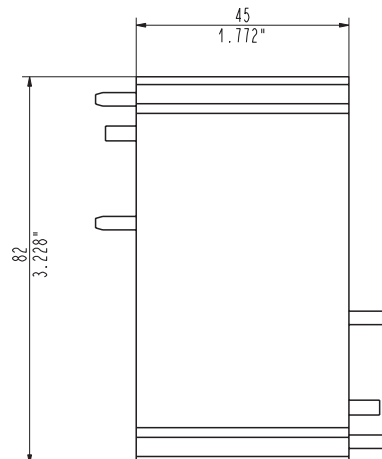

SMC072S045

Modular Supports

DIN Rail Hook

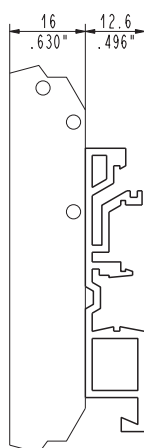

SMC072P020

Complete Module

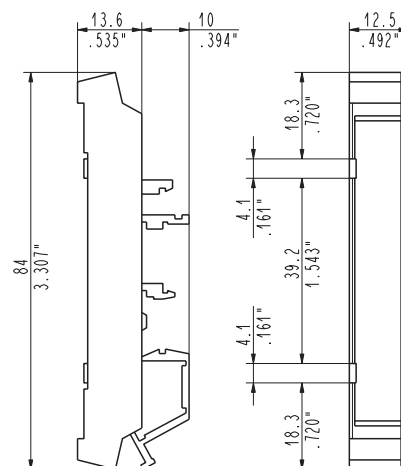

SMC072T013

Description	Part-Number	Pcs / pack
Lateral Element with Rail Hook	SMC072T011	50
Base Element	SMC072S011	50
Base Element	SMC072S022	50
Base Element	SMC072S045	50
DIN Rail Hook	SMC072P020	50
Complete Module	SMC072T013	50

The following table shows the configuration of support elements and the corresponding total length of the assembled support and the length of the PCB.

Length of PCB		Length of support		Lateral Element	Base Element	Base Element	Base Element	DIN Rail Hook	Complete Module
(mm)	(in)	(mm)	(in)	SMC072T011	SMC072S011	SMC072S022	SMC072S045	SMC072P020	SMC072T013
11,00	.433	12,50	.492						1
20,00	.787	22,50	.886	2				1	
31,25	1.230	33,75	1.329	2	1			1	
42,50	1.673	45,00	1.772	2		1		2	
53,75	2.116	56,25	2.215	2	1	1		2	
65,00	2.559	67,50	2.657	2			1	2	
76,25	3.002	78,75	3.100	2	1		1	2	
87,50	3.445	90,00	3.543	2		1	1	2	
98,75	3.888	101,25	3.986	2	1	1	1	2	
110,00	4.331	112,50	4.429	2			2	2	
121,25	4.774	123,75	4.872	2	1		2	2	

EXAMPLES OF INSTALLATION

SMC 072 Modular Supports

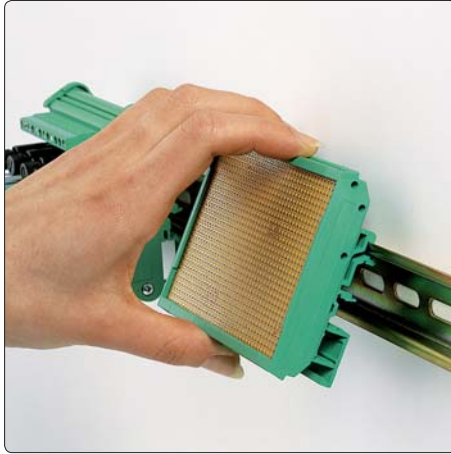
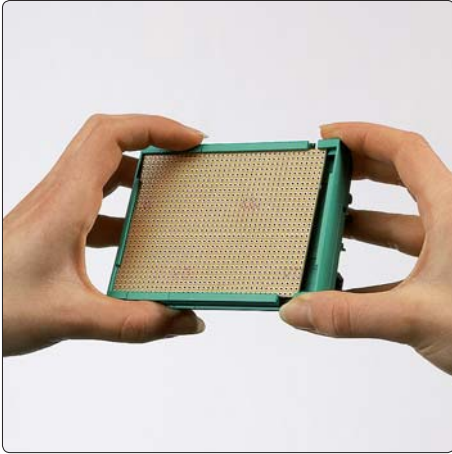
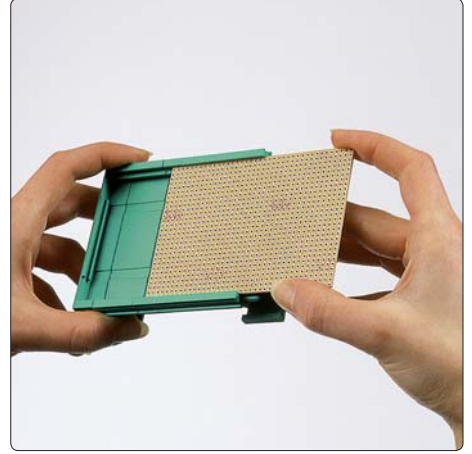
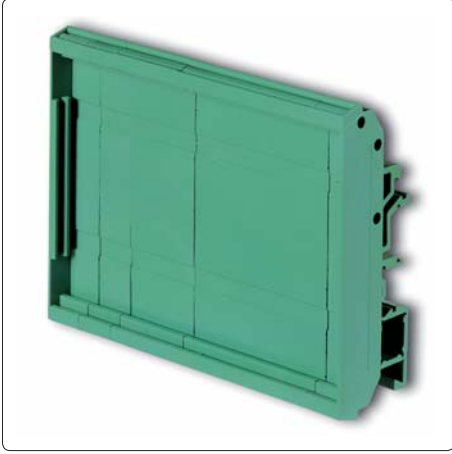







Accessibility

[english](#) | [italiano](#) | [deutsch](#) | [français](#) | [español](#) | [português](#) | [中文](#) | [РУССКИЙ](#)
[Home](#) | [Company](#) | [Products](#) | [Service](#) | [Contacts](#) | **Search**
e-mail password Accept the terms of use.

Enter

[Sign in](#) [Password mailing](#)**specific product search****SEARCH**Select the characteristics of the product you are looking for, then click **SEARCH**category: line: pitch: poles: mounting: voltage: Vcurrent: Awire section: **SEARCH****Modular Supports**

type	description	download
------	-------------	----------

SMC072 _____	modular support for PCB 72mm wide	datasheet
	SMC072T011 Lateral Element L10.5 H72	PCB width: 72 mm PCB thickness: 1.6 mm Standard color: Green Optional colors: Black Material: UL94 V-0 self-extinguishing polyamide PA 6.6 Pieces per package : 50 pcs pdf (248 kb)
	SMC072T012 Lateral Element L12.5 H72	PCB width: 72 mm PCB thickness: 1.6 mm Standard color: Green Optional colors: Black Material: UL94 V-0 self-extinguishing polyamide PA 6.6 Pieces per package : 100 pcs pdf (248 kb)
	SMC072T013 Complete Module L10.5 H72	PCB width: 72 mm PCB thickness: 1.6 mm Standard color: Green Optional colors: Black Material: UL94 V-0 self-extinguishing polyamide PA 6.6 Pieces per package : 50 pcs pdf (248 kb)
	SMC072S011 Base Element L11.25 H72	PCB width: 72 mm PCB thickness: 1.6 mm Standard color: Green Optional colors: Black Material: UL94 V-0 self-extinguishing polyamide PA 6.6 Pieces per package : 100 pcs pdf (248 kb)
	SMC072S022 Base Element L11.25 H72	PCB width: 72 mm PCB thickness: 1.6 mm Standard color: Green Optional colors: Black Material: UL94 V-0 self-extinguishing polyamide PA pdf (248 kb)

6.6

Pieces per package : 50 pcs**SMC072S045**Base Element
L45 H72**PCB width:** 72 mm
PCB thickness: 1.6 mm
Standard color: Green
Optional colors: Black
Material: UL94 V-0
self-extinguishing polyamide PA
6.6
Pieces per package : 50 pcspdf (248
kb)**SMC072P020**DIN Rail
Hook**PCB width:** 72 mm
PCB thickness: 1.6 mm
Standard color: Green
Optional colors: Black
Material: UL94 V-0
self-extinguishing polyamide PA
6.6
Pieces per package : 50 pcspdf (248
kb)