

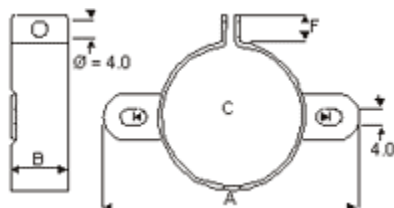

ACCESSORIES
Mounting Clips

DIMENSIONS (mm)
Horizontal Mounting

TYPE	CAN DIA	A	B	C	F
H1	25	40	22.3	12.8	10
H2	35	52	22.3	12.8	10

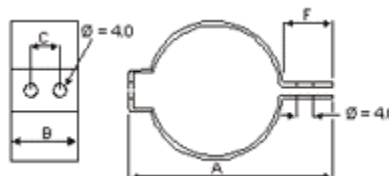

Vertical Mounting

TYPE	CAN DIA	A	B	C	F
V2	25	49	19	37	10
V3	35	58	19	45	9
V9	40	65	19	52.4	9.5

TYPE	CAN DIA	A	B	C	E	F
V4	51	75	25.4	64	5	10
V6	45	69.5	17.4	58	4	10
V8	63.5	88.9	25.4	77.5	5	9.5

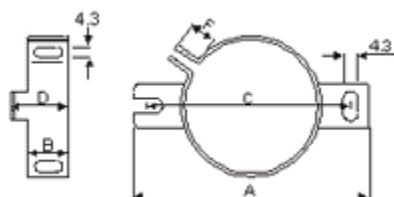
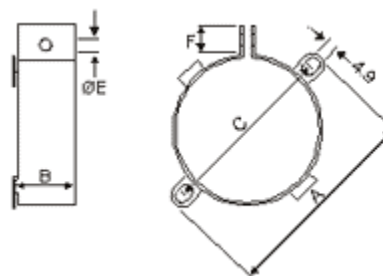

TYPE	CAN DIA	A	B	C	E	F
UTE2736	35	63	12.2	54	17.2	10

TYPE	CAN DIA	A	B	C	D	E	F
V10	65	90	40	30	5	4.5	-
V11	76	103	45.5	30	5	4.5	-
V90	90	116	53.5	30	5	4.5	-
UTE2737	50	75.5	33.5	27	4.3	4.3	39.5
UTE2738	65	88.5	39	27	4.3	4.3	45
UTE2739	72	97	44	28	4.3	4.3	50

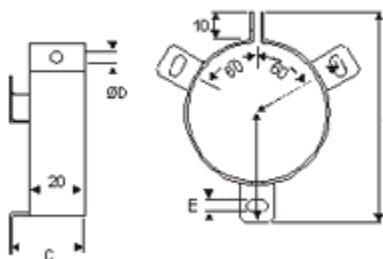

Material
Zinc plated steel

Note
When using mounting clamps care should be taken not to obscure any safety vent in the can.

Stud Mounting Kits

INSULATED VERSION
M8 Stud (M12 Stud)

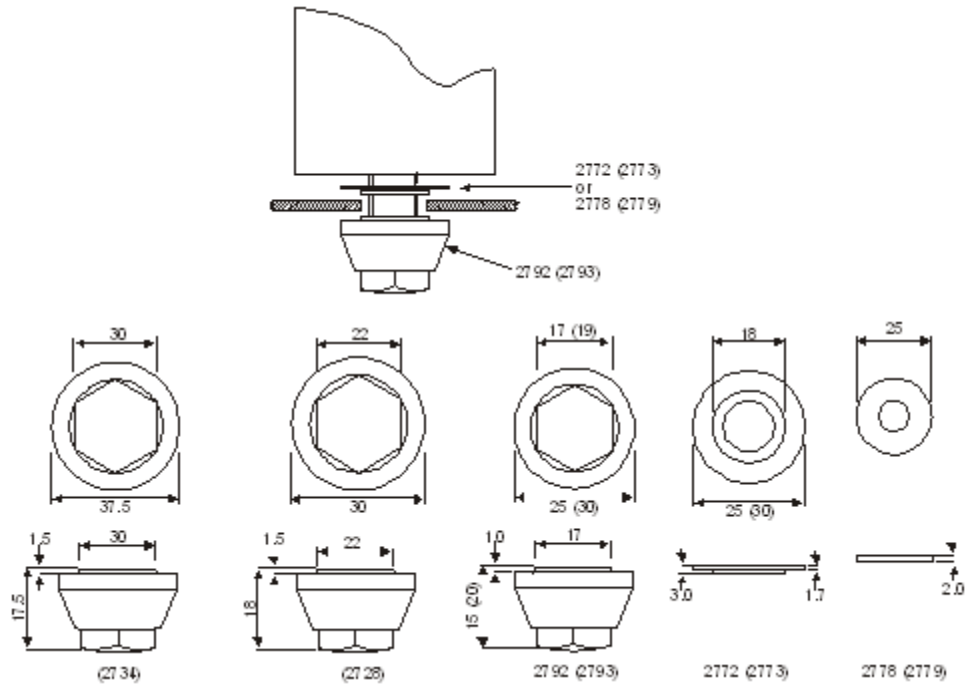

NON-INSULATED VERSION
M8 Stud (M12 Stud)

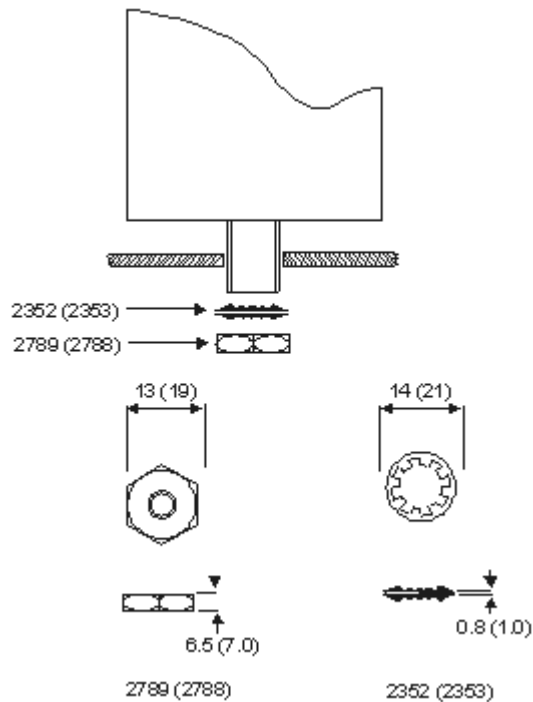

Kit Contents and Ordering Information

STANDARD KITS

Part code	Description	2740	2741	2782	2785
2352	Steel washer M8			●	
2353	Steel washer M12				●
2772	Stepped poly washer M8	●			
2773	Stepped poly washer M12		●		
2778	Plain poly washer M8	●			
2779	Plain poly washer M12		●		
2788	Steel nut M12				●
2789	Steel nut M8			●	
2792	Nylon nut M8	●			
2793	Nylon nut M12		●		
	Kit description	Ins M8	Ins M12	Non-ins M8	Non-ins M12

SPECIAL KITS

Part code	Description	2684	2685	2690	2691	2692	2693	2695
2352	Steel washer M8					●		
2353	Steel washer M12			●			●	
2772	Stepped poly washer M8	●			●	●		
2773	Stepped poly washer M12		●	●			●	●
2778	Plain poly washer M8				●	●		
2779	Plain poly washer M12						●	●
2788	Steel nut M12		●	●			●	●
2789	Steel nut M8	●			●	●		
2728	Nylon nut M12							
2734	Nylon nut M12							