

RevNo	Revision note	Date	By	Checked
-	-	-	-	-

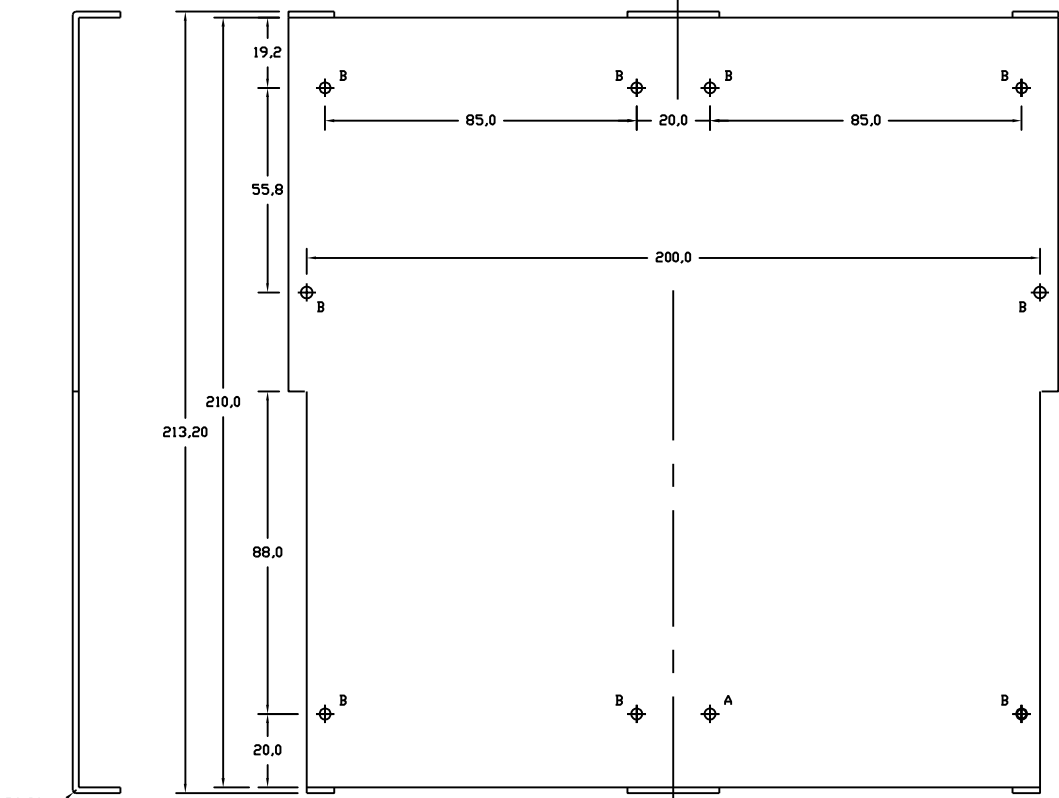
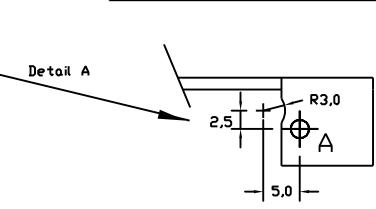
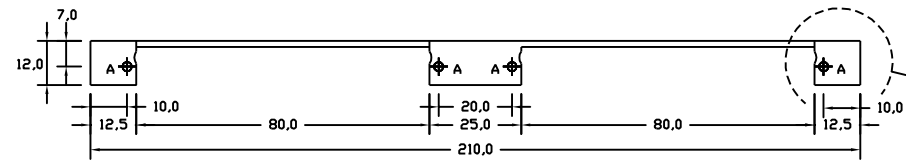

Extender Plate

Holes =
 A = 8 = \varnothing 2.50
 B = 10 = \varnothing 3.20

Material =
 1.6mm Aluminium sheet

Remove all burrs

Detail A repeats 8 times

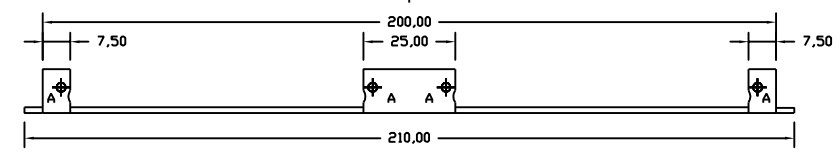

DM Associates
 33, Northbrook Road
 Aldershot, Hampshire. GU11 3HE UK
 Tel: 01252 330966
www.soemtron.org

Material	Tolerances 0 Decimal Places +/- 0.5
1.5mm Alu	Unless 1 Decimal Place +/- 0.25
Finish	Otherwise 2 Decimal Places +/- 0.10
Clean	Stated Angles +/- 2 Deg.

Dimensions in mm to BS308, DO NOT SCALE		Scale	Nts
Name	Date	Sheet	1
Drawn	MD Hatch	Next sheet	2
Checked	-	Drawing Number	Extender

Title		www.soemtron.org	
		Extender Board	
		Extender Panel Mechanical	
		A2	Issue A

RevNo	Revision note	Date	By	Checked
-	-	-	-	-

Edge brackets
x2 Left hand
(Mirrored right hand)



Center bracket x2

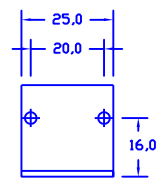

Edge brackets
x2 Right hand

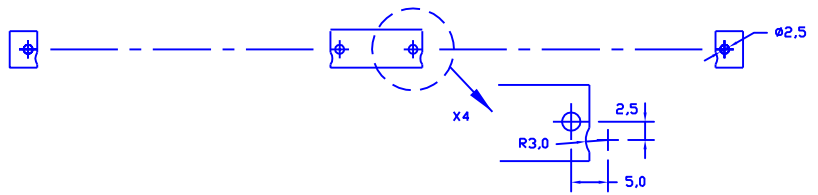
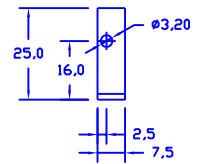

Support Brackets

Holes =
Edge -
x2 = $\phi 2.50$
Center
x4 = $\phi 2.50$
Material =
25mm X 25mm x 1.5mm Aluminium
angle
Remove all burrs
Detail A
Edge - 1 each
Center - 2 each



©2014 Mike Hatch. (www.soemtron.org)

DM Associates
33, Northbrook Road
Aldershot, Hampshire. GU11 3HE UK
Tel: 01252 330966
www.soemtron.org

Material	Tolerances
1.5mm Alu	0 Decimal Places +/- 0.5
Finish	Unless 1 Decimal Place +/- 0.25
Clean	Otherwise 2 Decimal Places +/- 0.10
	Stated Angles +/- 2 Deg.

Dimensions in mm to BS308, DO NOT SCALE		Scale	Nts
Drawn	MD Hatch	Sheet	2
Checked	-	Next sheet	3
		Drawing Number	Extender

Title	www.soemtron.org
	Extender Board
	Extender Brackets Mechanical
Issue	A2

RevNo	Revision note	Date	By	Checked
-	-	-	-	-

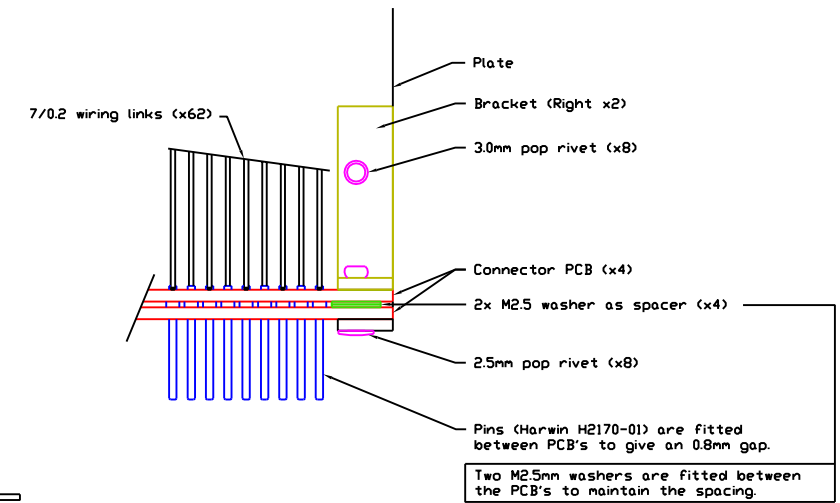
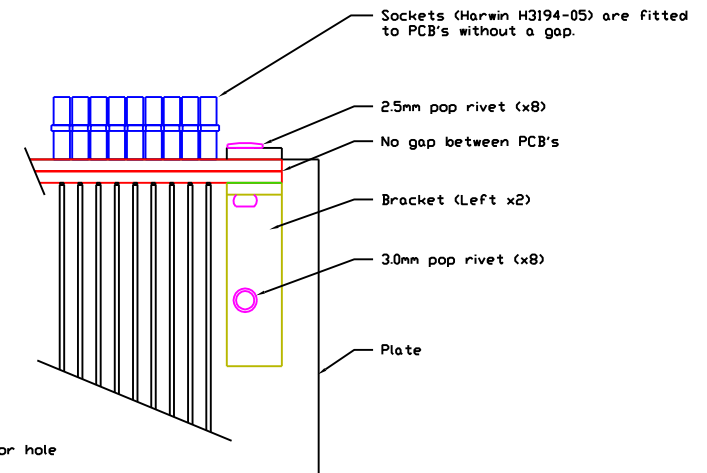
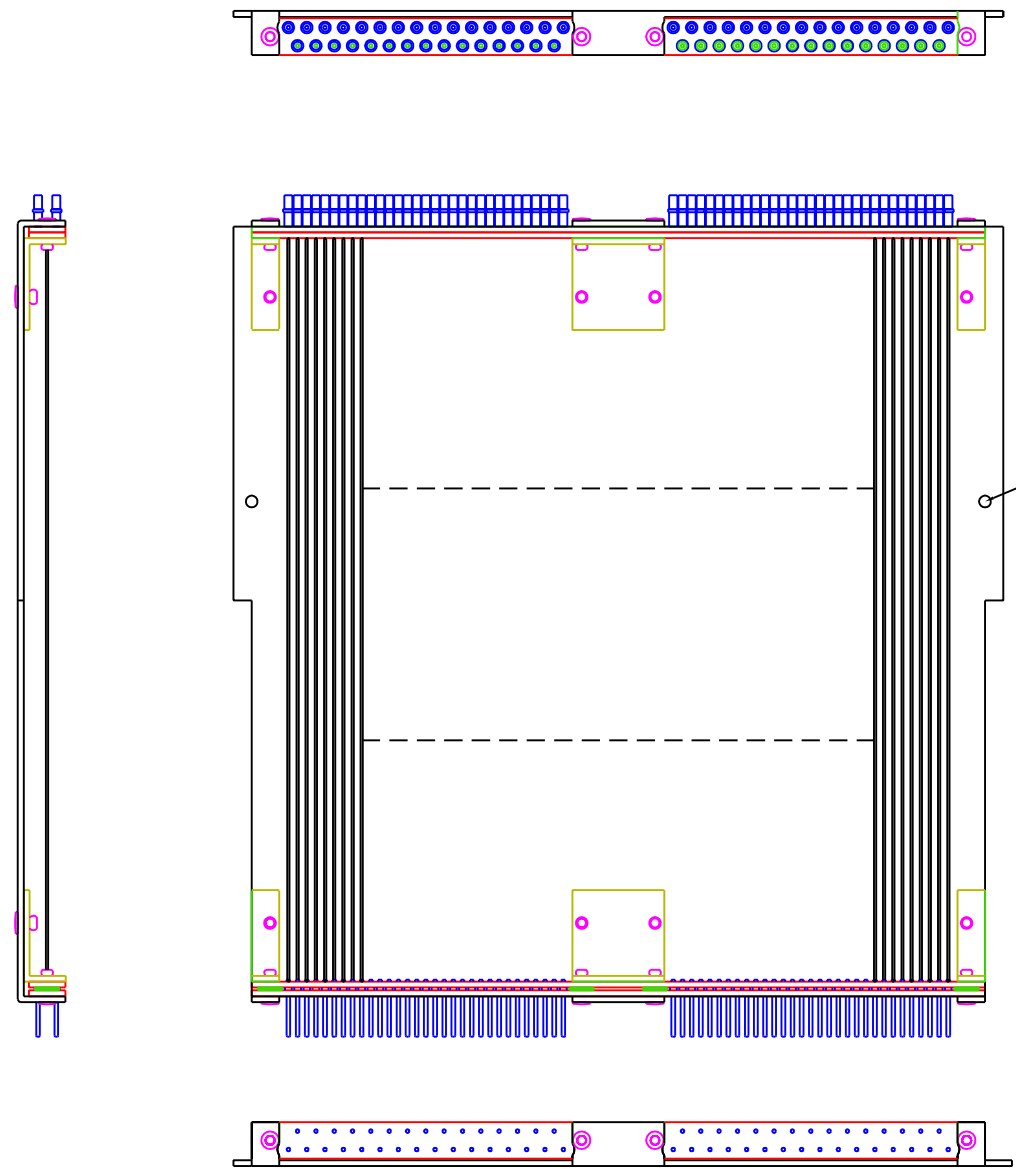

DM Associates
 33, Northbrook Road
 Aldershot, Hampshire. GU11 3HE UK
 Tel: 01252 330966
 www.soemtron.org

Material	Tolerances 0 Decimal Places +/- 0.5
1.5mm Alu	Unless 1 Decimal Place +/- 0.25
Finish	Otherwise 2 Decimal Places +/- 0.10
Clean	Stated Angles +/- 2 Deg.

Dimensions in mm to BS308, DO NOT SCALE		Scale	Nts	Title
Drawn	Name	Date	Sheet	www.soemtron.org Extender Board Extender Assembly
Checked	MD Hatch	16/1/2014	Next sheet	
			4	

Drawing Number	Extender	A2	Issue	A
----------------	----------	----	-------	---

RevNo	Revision note	Date	By	Checked
-	-	-	-	-

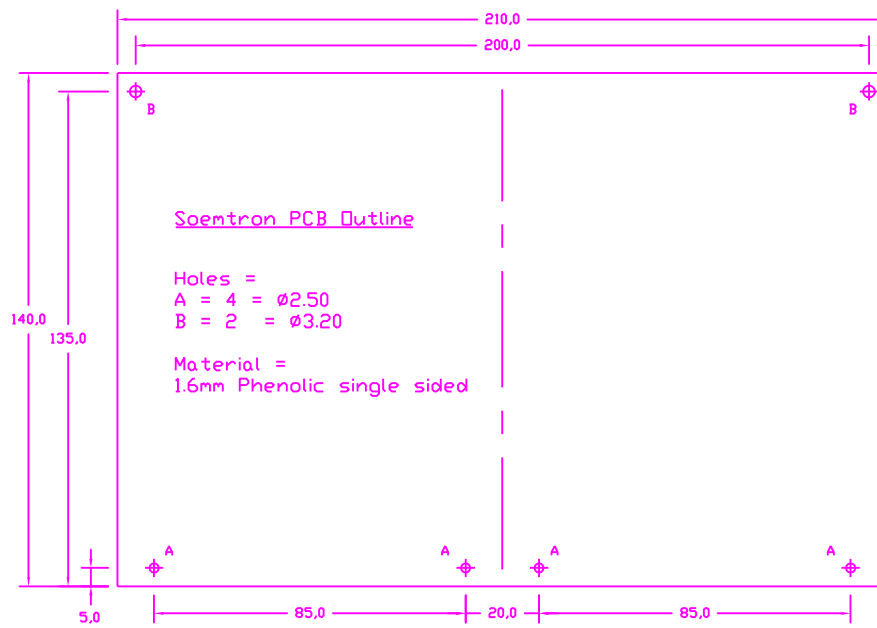

DM Associates
 33, Northbrook Road
 Aldershot, Hampshire. GU11 3HE UK
 Tel: 01252 330966
www.soemtron.org

Material	Tolerances 0 Decimal Places +/- 0.5
1.5mm Alu	Unless 1 Decimal Place +/- 0.25
Finish	Otherwise 2 Decimal Places +/- 0.10
Clean	Stated Angles +/- 2 Deg.

Dimensions in mm to BS308, DO NOT SCALE		Scale	Nts
Drawn	MD Hatch	Sheet	4
Checked	-	Next sheet	-
		Drawing Number	Extender

Title		www.soemtron.org	
		Extender Board	
		Soemtron PCB Board Outline	
		Issue	A